

Product Code

6697EM/9A2

3-Ways Motorized Ball Valve CO2
1.1/8" ODS 24V PS = 130 bar

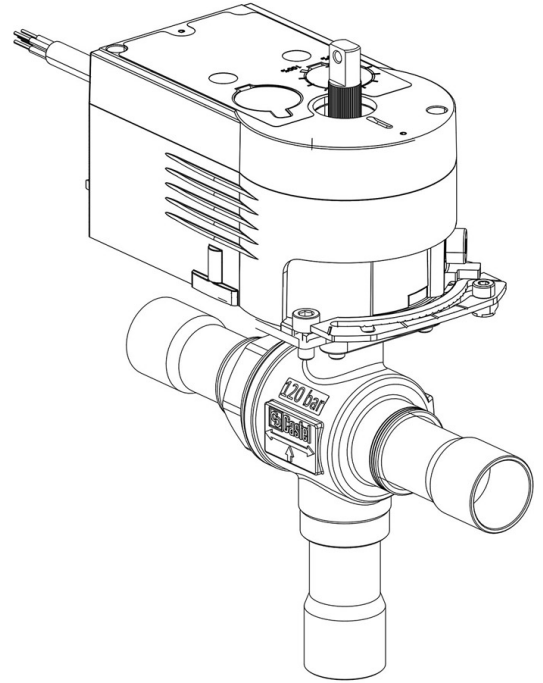

Product use

Accessories for use with refrigerant R744.

Product Details

Part number (1) 6697EM/9A2

Part number (1)

Connections ODS Ø [in.] 1.1/8"

Connections ODS Ø [mm]

P/N Actuator 9700/RA2

Torque [Nm] 10

Ball port Ø [mm] 24

Kv [m³/h] 15,9

PS [bar] 130

TS [°C] min. -40

TS [°C] max. +150

Package pcs 1

Notes where expressly stated

Castel non si assume alcuna responsabilità per eventuali errori nei cataloghi, opuscoli e altro materiale stampato o indicato nel sito Castel.it. Castel si riserva il diritto di modificare i propri prodotti senza preavviso. Tutti i marchi in questo materiale sono di proprietà di Castel. Tutti i diritti riservati.

Castel assumes no responsibility for any errors in catalogs, brochures and other material printed or indicated on the Castel.it website. Castel reserves the right to modify its products without notice. All trademarks in this material are the property of Castel. All rights reserved.

(1): including actuator and mounting plate
NB: proportional flow versions available