

Product Code

6690EM/M18A6

3-Ways Motorized Ball Valve-CO2
18mm ODS 230V
PS = 80 bar

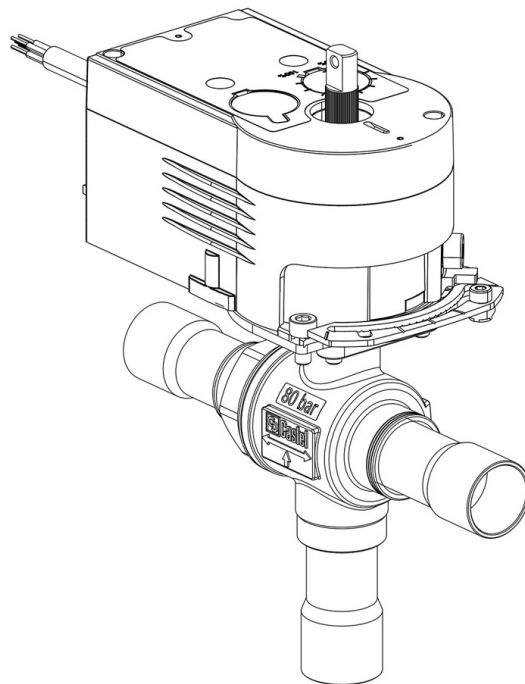

Product use

Accessories for use with refrigerant R744.

Product Details

Part number (1) 6690EM/M18A6

Part number (1) NEW

Connections ODS Ø [in.] -

Connections ODS Ø [mm] 18

P/N Actuator 9700/RA6

Torque [Nm] 10

Ball port Ø [mm] 13,5

Kv [m³/h] 4,6

PS [bar] 80

TS [°C] min. -40

TS [°C] max. +150

Package pcs 1

Notes where expressly stated

(1): including actuator and mounting plate

NB: proportional flow versions available