

Product Code

6690EM/17A6

3-Ways Motorized Ball Valve-CO2

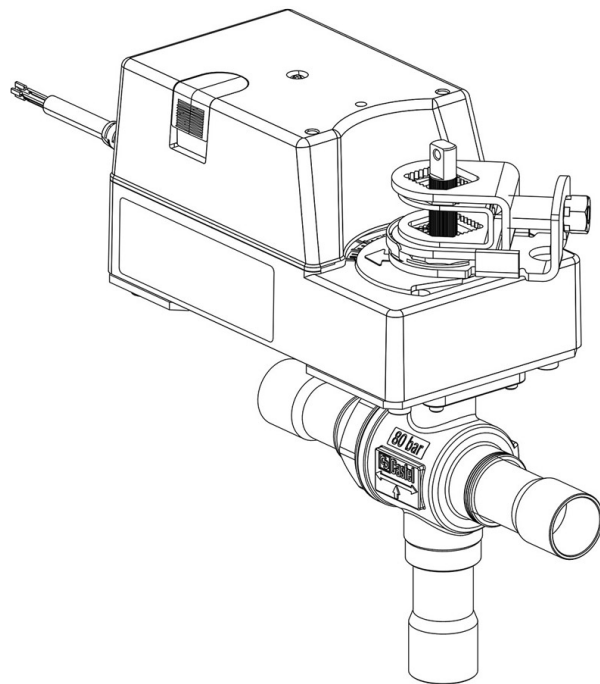

Product use

Accessories for use with refrigerant R744.

Product Details

Part number (1) 6690EM/17A6

Part number (1) NEW

Connections ODS Ø [in.] 2.1/8"

Connections ODS Ø [mm] 54

P/N Actuator 9730/RA6

Torque [Nm] 60

Ball port Ø [mm] 48

Kv [m³/h] 63,0

PS [bar] 80

TS [°C] min. -40

TS [°C] max. +150

Package pcs 1

Notes where expressly stated

(1): including actuator and mounting plate

NB: proportional flow versions available