

Product Code

6690B/M12

3-Ways Valves to be motorized
12mm ODS
PS = 45 bar

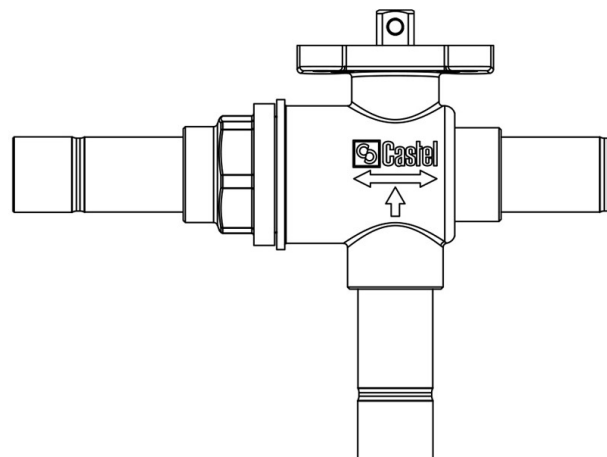

Product use

Accessories for use with the following ASHRAE 34:2019 refrigerants, Class A1:

HCFC (R22)

HFC (R134a, R404A, R407C, R410A, R507)

HFO (R1234ze)

HFO + HFC (R448A, R449A, R450A, R452A, R513A, R515A, R515B)

Product Details

Part number (1) 6690B/M12

Part number (1) NEW

Connections ODS Ø [in.] -

Connections ODS Ø [mm] 12

Ball port Ø [mm] 13,5

Kv [m³/h] 4,6

PS [bar] 45

MWP [psi] (2) 650

TS [°C] min. -40

TS [°C] max. +150

Package pcs 1

Notes where expressly stated

NB: proportional flow versions available

Castel non si assume alcuna responsabilità per eventuali errori nei cataloghi, opuscoli e altro materiale stampato o indicato nel sito Castel.it. Castel si riserva il diritto di modificare i propri prodotti senza preavviso. Tutti i marchi in questo materiale sono di proprietà di Castel. Tutti i diritti riservati.

Castel assumes no responsibility for any errors in catalogs, brochures and other material printed or indicated on the Castel.it website. Castel reserves the right to modify its products without notice. All trademarks in this material are the property of Castel. All rights reserved.

- (1): with adapter for servomotors with ISO mounting flange
- (2): according to UL approval
- (3): not UL approved
- (4): UL approval ongoing